

THINK COMPACT EDGE EASY

— ProWoodTech —

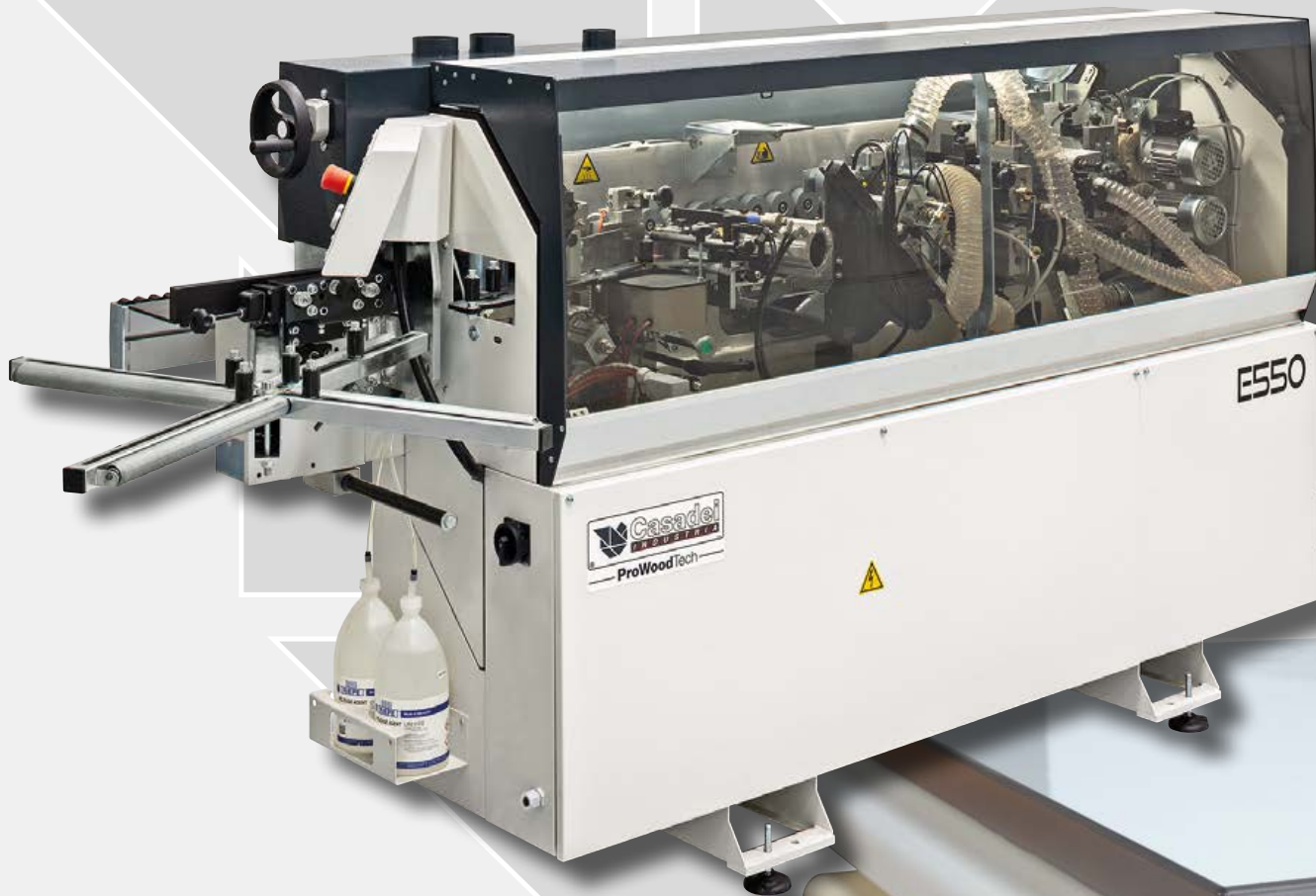

## E550 PM

Automatic edge bander with hot melt (EVA) or polyurethanic (PUR) glue pot upon request.  
Chain panel feeding and pre-milling

## E550 PMCR

Automatic edge bander with hot melt (EVA) or polyurethanic (PUR) glue pot upon request.  
Chain panel feeding, pre-milling and corner rounding unit



Site



E550



YouTube

# E550

Automatic edge bander with hot melt (EVA) or polyurethane (PUR) glue pot upon request.  
Chain panel feeding and pre-milling



ProWoodTech



- Maximum finishing quality
  - ✓ Chain feeding system
  - ✓ Pre-milling
  - ✓ Gluing with polyurethane glue (Opt.)
  - ✓ Corner rounding unit (E550PMCR)
  - ✓ 3 free spaces for finishing units
- High performance
  - ✓ 9 m/min feed speed
  - ✓ 50 mm panel height
  - ✓ 3 mm edge coils
  - ✓ 5 mm solid wood strips
- Minimum space occupied
  - ✓ 3.2 m (PM version)
  - ✓ 3.7 m (PM CR version)
- Easy to use
  - ✓ Unit settings with a piece of edge
  - ✓ Easy and intuitive use of machine
  - ✓ Flush trimmers with multiprofile tool (thin-R1-R2- strips)

## E550 PM

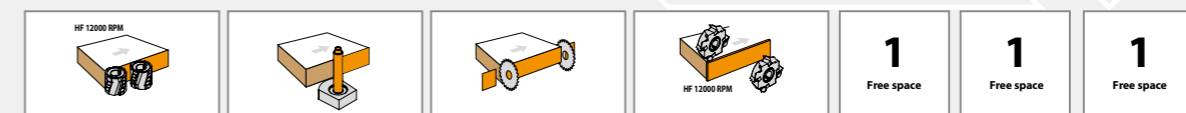

## E550 PMCR

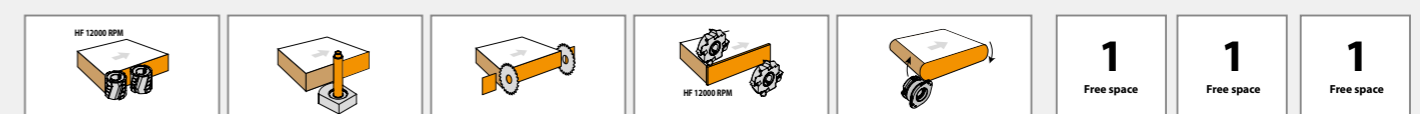

THINK COMPACT EDGE EASY

Standard

TOUCHME

Casadei  
INDUSTRIA  
ProWoodTech

Optionals



**Touchscreen control**  
Easy to use, Intuitive and Immediate

- 7" Colour display
- Save n° 99 working programmes
- Impossible to go wrong; the graphic visualizes directly the result of the process on the edged panel
- Just one click to choose the desired workmanship

### Glueing unit PUR

Revolutionary glueing technology

“At last, perfect glueing for every level of investment”

- Water resistant at any temperature: hold and bonding of edge which cannot be obtained by any other traditional glueing systems.
- Invisible joints: finishing quality incomparable in regards to other traditional glueing systems

PUR

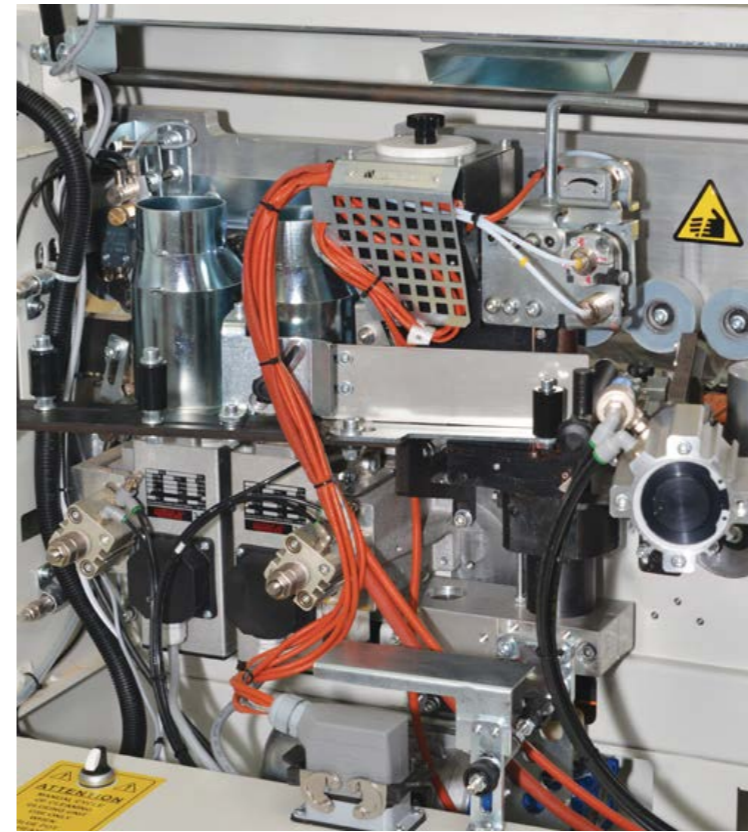

- Processing both with PUR and EVA glue
- With PUR glue it is possible to stop machine (up to 4 days) without having to effect any cleaning procedure.
- Automatic cleaning of glue spreader roller
- Glue roller with integrated heating uniform and constant glue temperature
- Granule manual loading (glue pot 0,5 Kg)
- Automatic glue drainage cycle. Equipped with a drip tank of the glue discharged during the drain cycle
- Upon request an additional interchangeable glue pot is available.

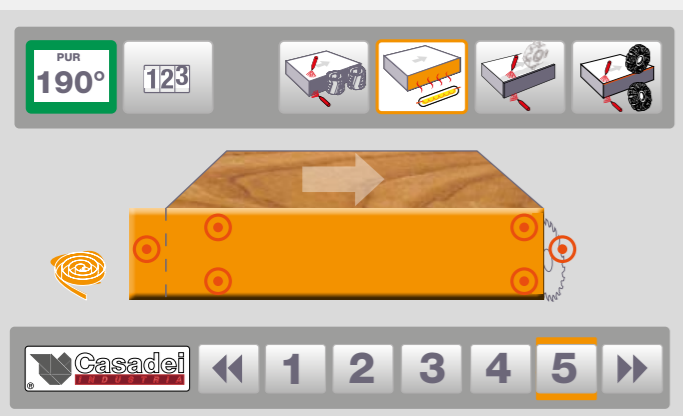

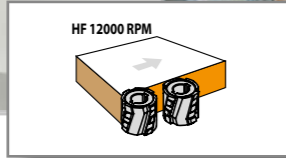

### Feeding fence

PRACTICALITY AND PRECISION

- Feeding fence with micrometric adjustment and numerical dial.
- Variable milling up to 2 mm max with 8 - 50 mm panel height

### Pre-milling

INVISIBLE GLUEING LINE

- DIAMOND tools  $\varnothing = 60$  mm H = 52 mm
  - HF motors 200 Hz - 12.000 rpm - 0.75 kW (each)
  - HF motors 200 Hz - 12.000 rpm - 0.75 kW (each)
- Dedicated suction system and blower for panel cleaning before glueing

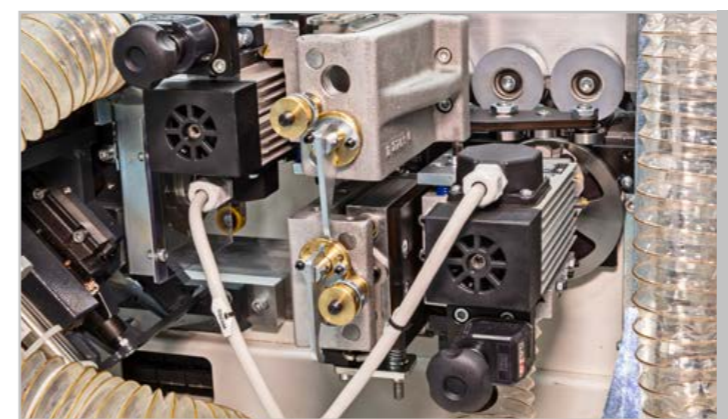

### Flush Trimming unit

FOUR PROCESSES

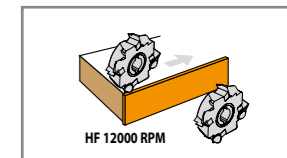

- Easy to change edge when processing Thin/Thickness 1 mm/ Thickness 2 mm/Soldi wood
- The system "reads" the edge thickness, making mistakes impossible!
- N. 2 motors HF 200 Hz - 12.000 RPM - 0,37 Kw

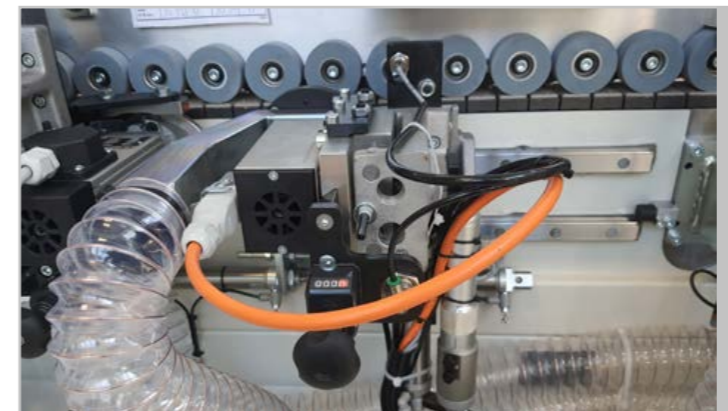

### Corner Rounding unit (E550 PMCR)

PERFECT FINISHING

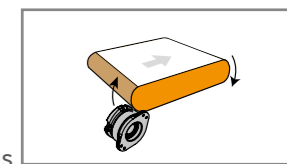

- Finishing of front and rear corners on straight, bevelled and postformed panels
- Diamond cutterblock
- Possibility to select from PLC the processed front, rear or complete panel



### Glueing unit

PERFECT GLUEING, QUICK AND PRACTICAL SET-UPS

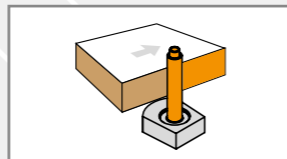

- 6 heating elements to guarantee uniform glue temperature.
- Motorized glue spreading roller with an internal electrical heating element.
- Teflon-coated glue pot to permit complete and rapid cleaning.



### End Trimming unit

PERFORMANCE AND VERSATILITY

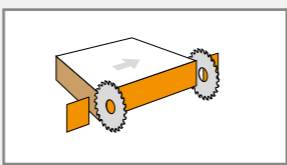

- 2 blades for perfect front/rear end trimming on all types of edges
- Operating cycle controlled by PLC
- HF motor 200 Hz - 12.000 rpm - 0.22 kW
- Integrated suction system

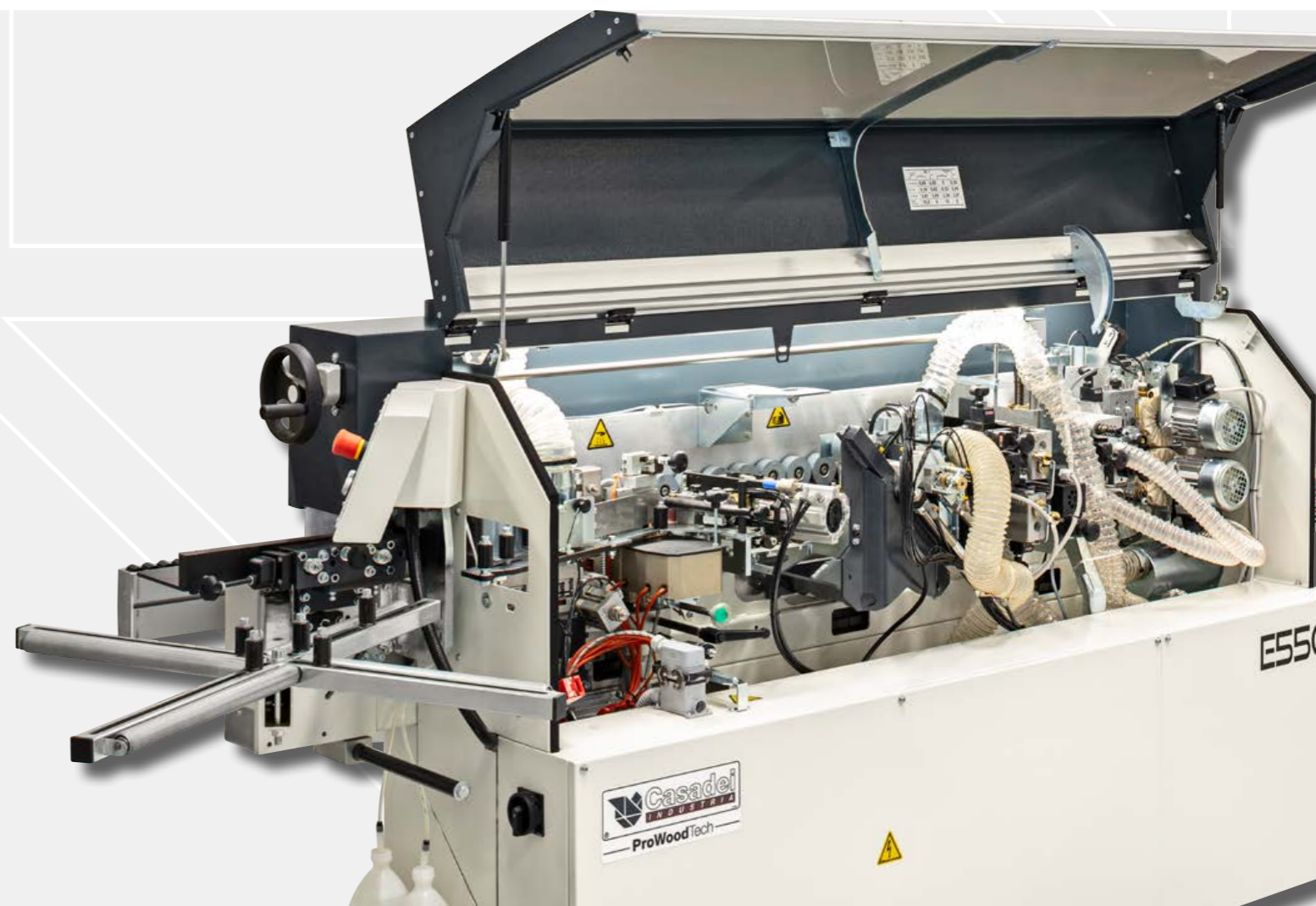

### Anti-adherence / release agent spraying unit



**INSTANT PERFECT CLEANING**

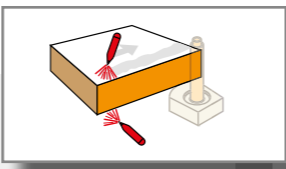

- Spray function controlled by PLC
- 2 sprayers (lower and upper) and liquid tank

### Antistatic and Cooling Spray Unit

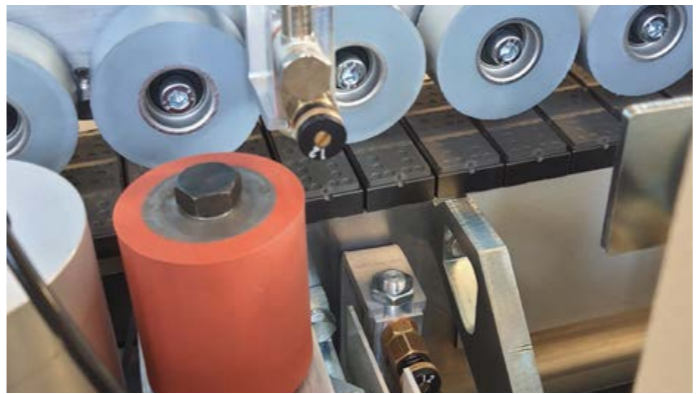

**ALWAYS USE BEST WORKING CONDITIONS**

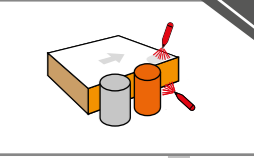

- Function of spray controller by PLC electrical
- N.2 sprayers (bottom and top) and liquid tank
- Suggested optional when the PURE gluing unit is foreseen
- Alternatively you can choose the slipping liquid for glossy and delicate panels and edges (High-gloss)

### Infrared lamp

**TO GUARANTEE THE BEST GLUEING CONDITIONS**

- Creates the best conditions for perfect glueing.
- Heats panels and removes all traces of dampness.

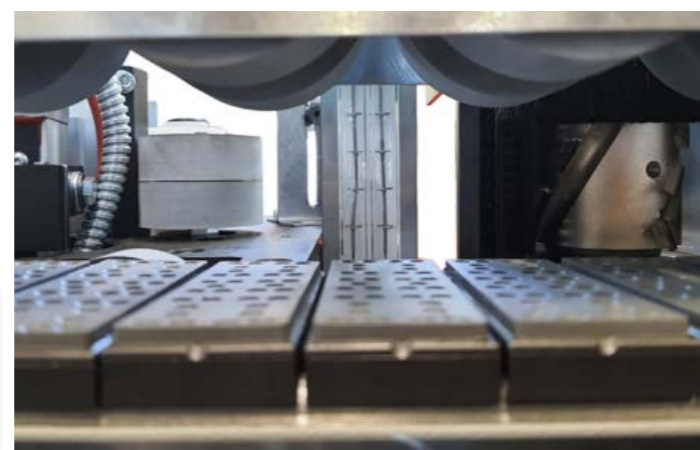
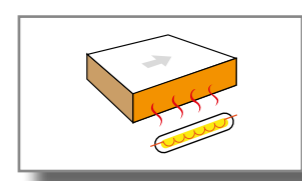

### Edge Scraping unit with Nesting option



**PERFECT PLASTIC EDGES EVEN IN BACKLIGHT**

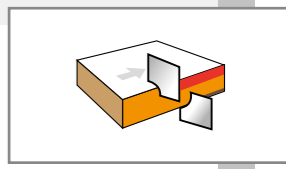

- Blowers for detachment and removal of shavings.
- Dust extraction system complete with box to separate and collect edge scraping shavings.

### VR or VS end trimming group with vertical rounding or bevel function

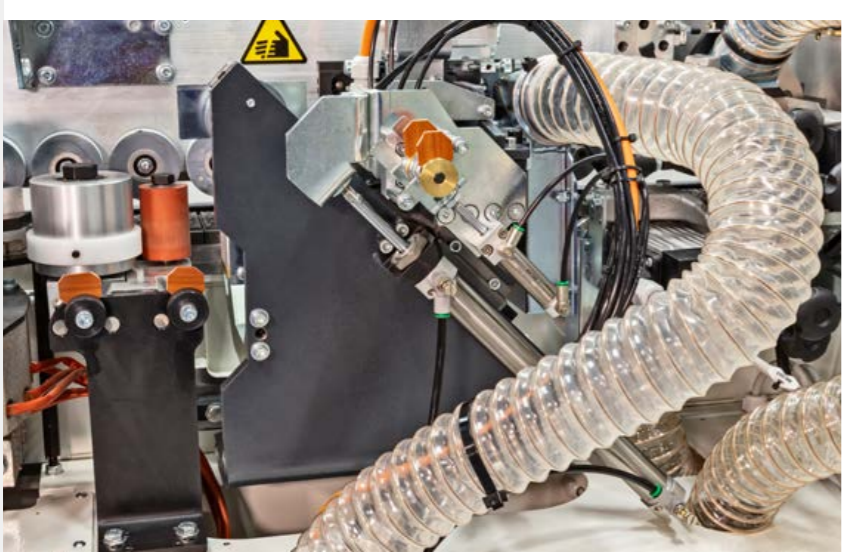

■ VR or VS end trimming group to remove and mill edge excess on front/rear side of the panel

- 2 processing modes:**
- "VR" radius (ABS and PVC thick edges)  
straight (thin edges and wooden strips)
  - or
  - "VS" bevel(thin edges)  
straight (thin edges and wooden strips)

■ Unit managed by the electronic control with the possibility to specifically choose the processing mode for the front and the rear of the panel

■ High frequency motor 0,22kW - 12.000 RPM

■ Integrated dust extraction system that includes the la extractor hood of the wood chips and flexible hose for connection to the external port D=120mm



VR



VS

### Cleaning spray agent unit



**MIRROR FINISHING**

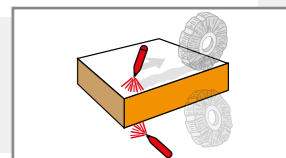

- Spray function controlled by PLC.
- 2 sprayers (lower and upper) and liquid tank.

# E550

## Buffing unit

### BRIGHT AND SHINY EDGES

- Uniform colouring even on processed edges.
- Panel cleaning
- 2 motors rotating at 1.400 rpm.
- 2 brushes diameter 120 mm

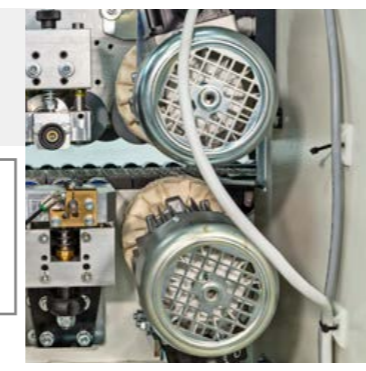
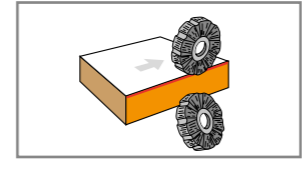

## Glue Scraping unit with Nesting option

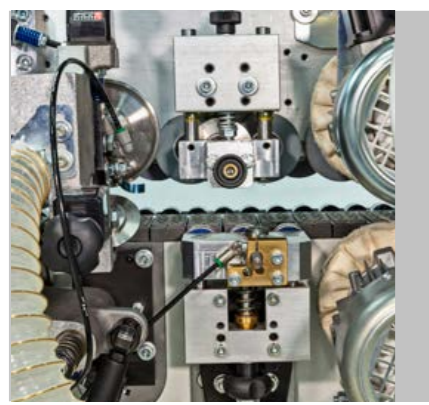

### REMOVAL OF EXCESS GLUE

- Copier discs with automatic cleaning system.
- Two separate knobs which allow an easy positioning of the tool and a fast exclusion of the unit.

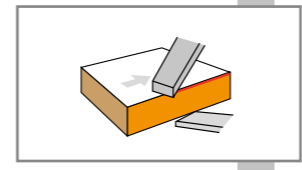

## Internal LED light

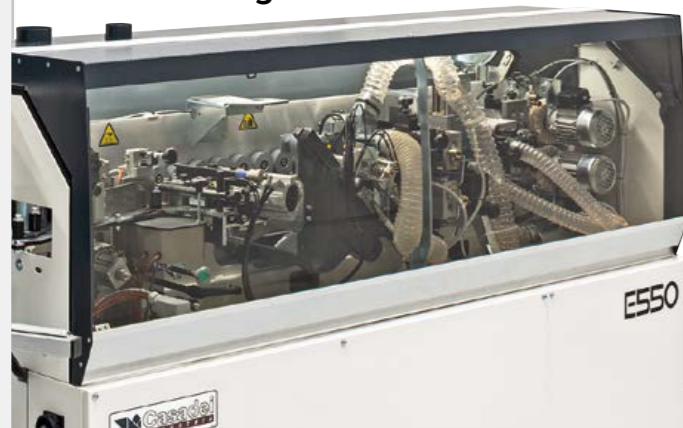

### ALL UNITS UNDER CONTROL

- The internal led lights on the units allows to make adjustments in safety, even with bad outside lighting

## Extra panel supporting roller conveyor.

- Improves the processing of large panels.



## Technical features

Min./max. panel height	min 8 - max 50 mm
Min./max. edge thickness	0,4 - 3 mm (coils) / 0,4 - 5 mm (strips)*
Panel width	min. 70 mm
Panel length (Side being processed)	min. 110 mm
Panel feed speed	9 mt/1'
Pre-milling motors (each)	200 Hz - 12.000 rpm - 0.75 kW
Glue pot heating element	1315 W - 6 cartridges
End trimming motor	200 Hz - 12.000 rpm - 0.22 kW
Flush trimming motors (each)	200 Hz - 12.000 rpm - 0.37 kW
Cutterblocks with combined WIDIA disposable Knives (radius/bevelled) Ø 75 mm Z4 - hole Ø 16 mm	
Total power installed	5 kW approx.
Weight	525 Kg approx.

\* the maximum thickness of the strip depends on wood hardness

## Compositions

### E550 PM

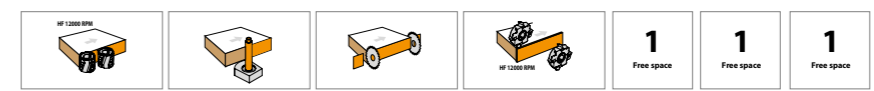

### E550 PMCR



- Options for free spaces

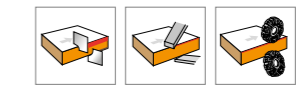

## Overall dimensions

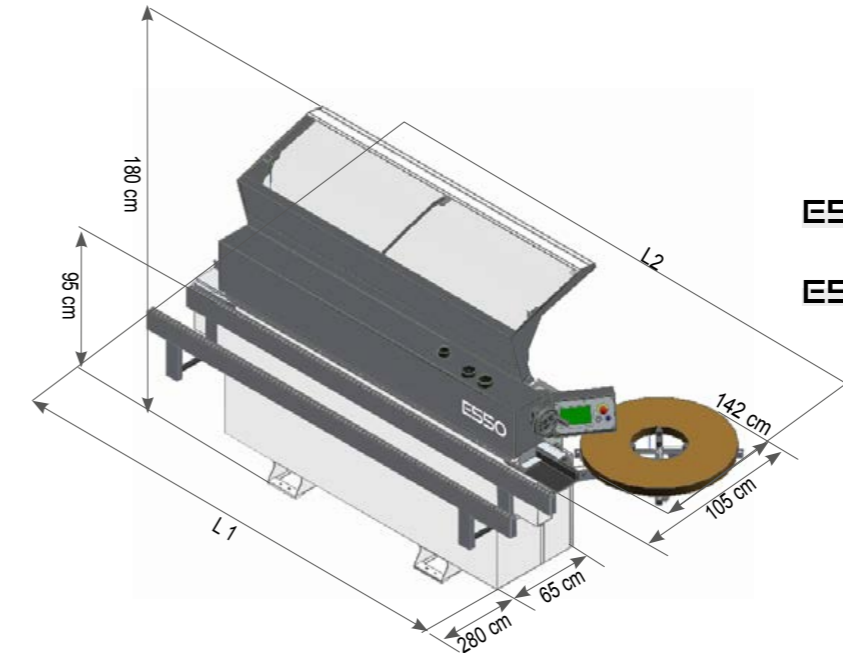

	L1 cm	L2 cm
E550 PM	261	313
E550 PMCR	311	363



— ProWoodTech —

**Casadei Industria WOOD S.r.l.**  
Via Guardia di Rocca, 14  
47899 Serravalle  
Repubblica di San Marino  
Tel. +378 0549 960011  
Fax +378 0549 955010  
[www.casadei-industria.com](http://www.casadei-industria.com)

**THINK COMPACT EDGE EASY**